

# Cat7/Class F New Installation Concept New infrastructure

Handbook

## CONTENTS

1	Introduction	3
2	What is the Cat7/Class F installation concept	3
3	Distribution centre	3
	3.1 Patch Modules	3
4	How to handle cable management	4
	4.1. Cable length	5
	4.2. Bend radius	5
5	How to reduce noise in Power Link	6
6	Non balanced speakers	6
7	! Grounding !	7
8	Installation examples with bill of material	9
9	Assembly of connectors	10
	9.1 Numbering of cables and connectors	11
	9.2 How to crimp a BeoNet RJ45 plug	11
10	How to test the installation	14
	10.1 Simple Ethernet cable tester	14
	10.2 Advanced cable tester	14
11	New infrastructure Components	15
12	Questions and answers	20

## 1 Introduction

This handbook contains guidelines and installation practices for the new Bang & Olufsen distribution system.

The new installation concept is intended to replace the existing ML system cabling and ensures future compatibility.

## 2 What is Cat7/ Class F installation concept

The new installation concept is based on Cat7/Class F double shielded Ethernet cable. This will eventually replace Master Link and Power Link cables. The new installation concept ensures backward compatibility at the same time as preparing for the new digital world. Cat7/Class F double shielded cable has been selected because of its high bandwidth capability for future digital systems and for its resistance to noise when used to carry analogue audio signals instead of Power Link cables when used with, for example, BeoLab 5 loudspeakers.

To ensure high flexibility all connections must be wired to the distribution centre. Please see drawing in section 4.

Connectors for wall plates are available in two versions. Choose a straight or angled BeoNet connector depending on space behind the wall plate and placement of conduit.

The difference between these two connectors is how the installation cable is mounted in the wall.

- Straight - where the cable goes directly into the back of the connector
- Angled - where the cable goes into the side of the connector

Face plates differ in every country. Please contact your local wall plate supplier for further information in your country.

## 3 Distribution centre

All cabling goes back to a central area. This could typically be a technical room, equipment closet or another appropriate location.

There are two types of cabinet available for the distribution centre.

- Inwall "flush mounted"
- Surface mounted

In case of large installations, it is possible to place more Distributions Centres in one installation (e.g. one on each floor).

- For Master Link there must be a connection from centre to centre
- Power Link is done locally on each floor
- For Ethernet, a Switch must be placed on each floor and the "input" cable must come from the Router that provides the Internet connection.

### 3.1 Patch modules

Patch modules are available in two versions for use with cabinets or 19" rack systems:

- Master Link patch module with 6 x RJ45 connections.  
6 products can be connected to one module.
- Power Link patch module with 6 x RJ45 connections.  
2 pair of speakers can be connected to one module.

Both modules must be mounted with a BeoNet bracket made for use in cabinets or a 19" rack.

Example of how to wire a Master Link module

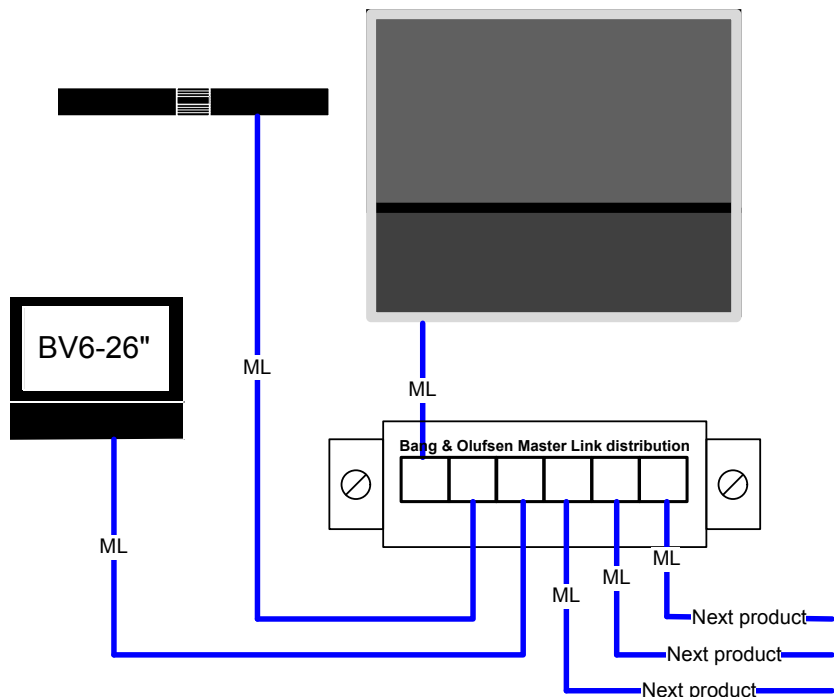

Example of how to wire a Power Link module

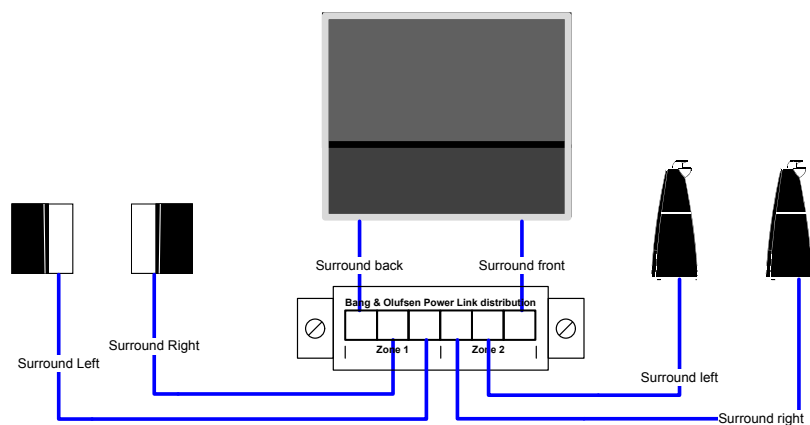

A subwoofer would normally be connected directly to the TV, however if the wiring is done via the distribution centre it must be patched to connector.

#### 4 How to handle cable management

To ensure a reliable system, it is important to follow a few guidelines during installation. It is especially important to ensure a minimum respect distance of 50 mm (2") between a/c power cables and BeoNet cables, and to ensure that ground (earth) connections are made according to the description.

Important !

When securing cables you must take care not to pull ties too tight. This can crush and damage the twisted cables causing a lowered bandwidth or cable failure.

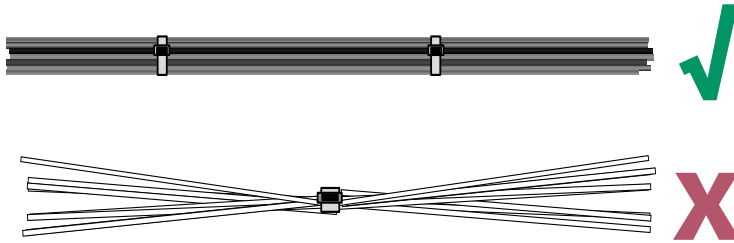

Important !

The distance between mains a/c power cables and BeoNet cables must be greater than 50 mm (2") to avoid magnetic disturbance. BeoNet cable must not be run in the same conduit as a/c mains cable if using cable management systems such as flex tubing or conduit.

Important !

Rules for grounding (earthing) must be followed closely. See section 5.

#### 4.1 Cable length

Maximum length of installation cable per outlet is 90 m/290' (from cabinet or rack to wall plate).

Maximum length of BeoNet product cable is 10 m/32' (from product to wall plate).

Maximum length of Master Link cable that may be run in a Master Link system today is 400 m/1300'.

Maximum length of BeoNet cat7/Class F that may be run as Master Link is increased to 1000 m/3250'.

Maximum length of Power Link cable today is 100 m/325' in a system.

Maximum length of BeoNet cat7/Class F that may be used as Power Link can be 300 m/984'.

Example of cable lengths

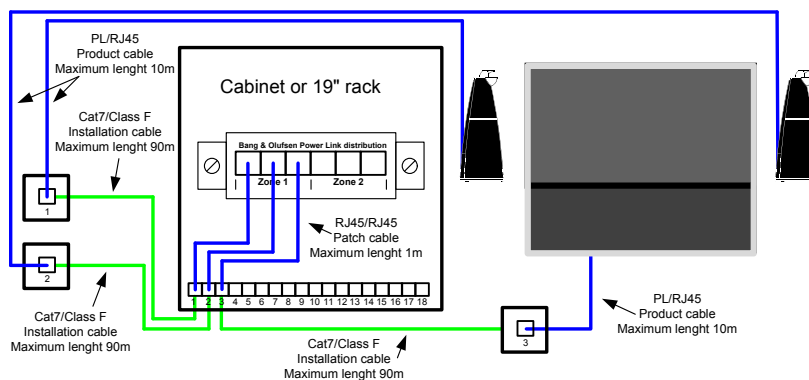

#### 4.2 Bend radius

Minimum bend radius for installation cable (horizontal cable) is 75 mm/3". Part number 6250027.

Minimum bend radius for special plenum installation cable (CL2P rated) is 150 mm/5.9". Part number 6250030.

Maximum bend radius for product cable is 20 mm/0.8". Part number 6250026:

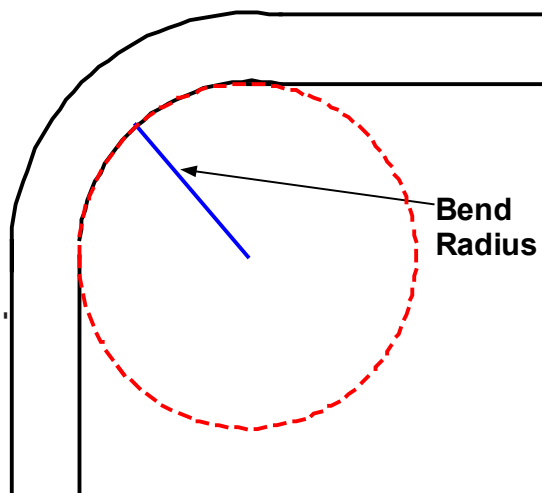

## 5 How to reduce noise in Power Link

If the building/house is placed in an area with a lot of magnetic or electrical noise, a nanoperm coil can be used to significantly reduce the affect.

The coil is available as part number 6710038. Place the coil somewhere between the Power Link output and the wall inlet RJ45.

How to make 9 windings on the coil.



## 6 Non balanced speakers

Pre-ICEpower loudspeakers with non balanced input must be mounted with a special non balance converter box.

Part number 3376078

This is only necessary if BeoLab loudspeakers without ICEpower amplifiers are used.

Present versions: BeoLab6000, BeoLab8000 and older versions of BeoLab4000, as well as older models.

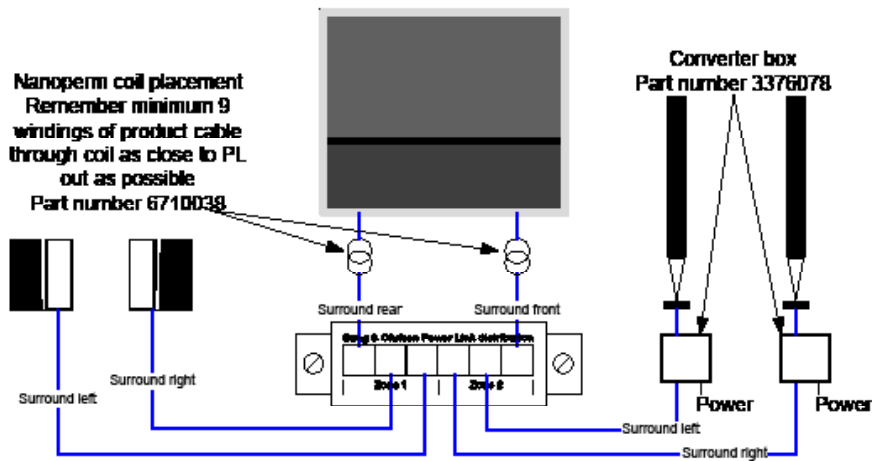

## 7 ! Grounding !

Grounding the installation is very important to eliminate any possible electrical hazard and to avoid noise in the loudspeakers.

All BeoNet cat7/Class F installation concept components are shielded.  
If not grounded properly the customer can experience an electrical shock!

Always use the ground from an electrical mains installation.  
Always use the galvanic isolator if an external antenna signal is connected to the system.

Always remember that grounding of class 1 product is very important. Grounding through cat7/Class F cable is not sufficient. Class 1 products must be grounded according to authorities' rules. The Cat7/Class F shield and accompanied connections are not rated to function as safety ground, carrying the current needed to blow the mains fuse.

Primary goal of earthing/grounding.  
To protect the installation from electrostatic discharge.  
To protect customer from electrical shock from the sum of leakage current from all the equipment connected to the network.  
BeoNet ground must be connected to existing earth ground installation in the building.

Example of structured grounding of BeoNet distribution centre cabinet and galvanic isolator.

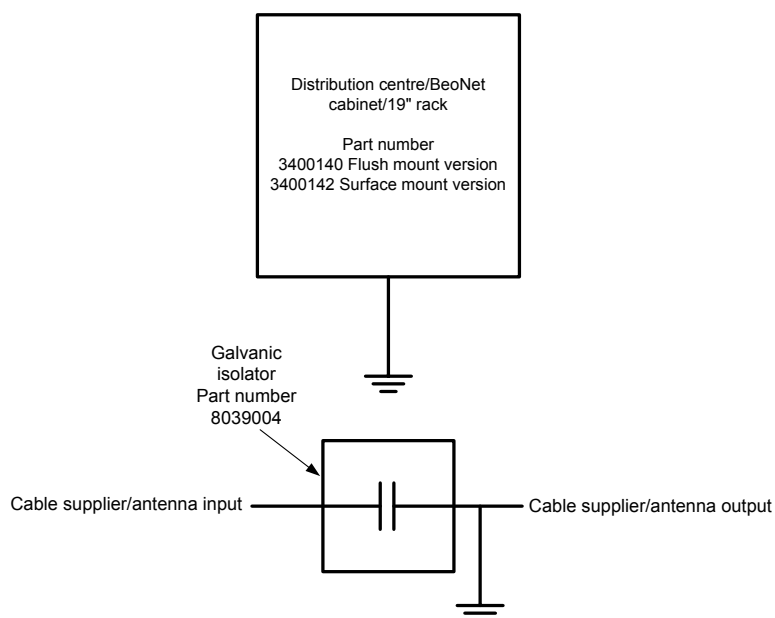

How to wire earth in a surface mount cabinet

Connect all wires to common ground. Then connect the common ground to the building's earth ground.

*Picture not ready*

How to wire earth in a flush mount cabinet.

Connect all wires to common ground. Then connect the common ground to the building's earth ground.

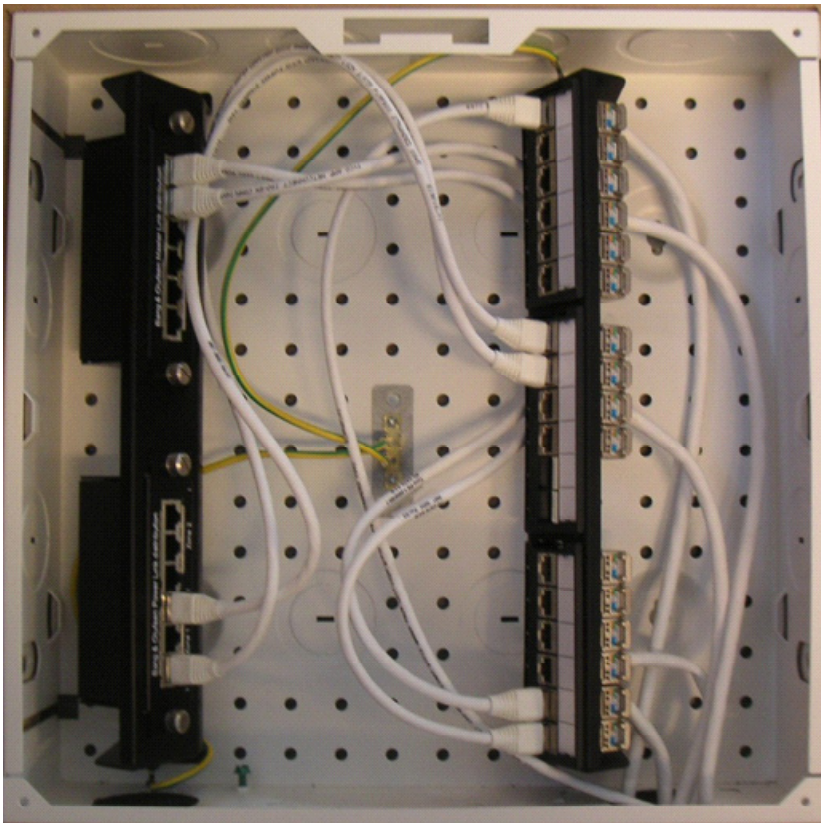



8 Installation examples with bill of material

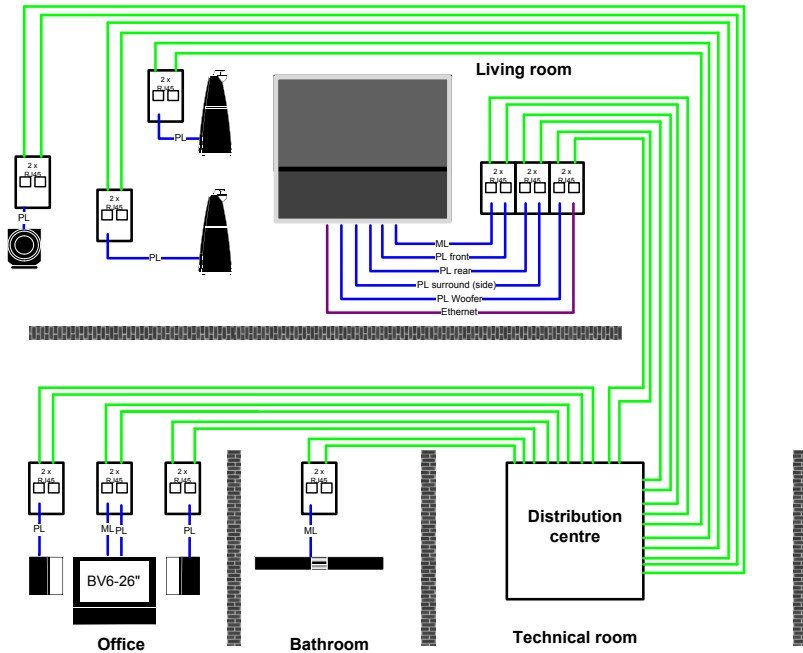

Bill of material

Part number	Pieces	Description
6250027	1 reel	BeoNet Cat7/Class F installation cable
7221200	1 package	BeoNet connector straight or angled
Various types	10	Face plates. (various types)
3400142	1	Distribution centre cabinet for surface mount
3153293	1	BeoNet bracket for connector in cabinet
3153287	2	BeoNet bracket for patch module
8052351	3	BeoNet Power Link patch module
8052352	1	BeoNet Master Link patch module
Various lengths	14	BeoNet patch cables
Various lengths	10	BeoNet product cable PL to RJ45
Various lengths	3	BeoNet product cable ML to RJ45

Description of how many outlets are needed for different products:

Main TV point (video master)

- 8 x Cat 7- (ML, PL Front, PL Surround, PL Rear, PL Sub, Ethernet + 2 spare)
- 3 x Coax - TV, DTV + RF Distribution
- 4 x Mains Power - TV, Set top Box, +2 spare
- SCART back to centrally stored Set Top Box - to RF distribute signal from STB

Link TV

- 4 x Cat 7 (ML, PL Front, Ethernet + 1 spare)
- 2 x Coax - RF, TV, DTV
- 2 x Power cord - TV + STB

Audio System

- 3 x Cat 7 - ML, PL, Ethernet
- 2 x Coax - Radio, DAB
- 1 x Power cord

Speakers

- 1 x Cat 7 (per loudspeaker)
- 1 x Power cord (per loudspeaker)

BeoLink Passive/Active  
 2 x Cat 7 - ML, PL  
 1 x Power cord

### 9 Assembly of connectors

Tool for stripping installation cable and crimp the connectors. Part number 3642008

Important !

Ensure that you use the same wiring system A or B (color combination) at both ends.

<p>(E): S/FTP cable: Prepare the cable and cut the pair foils as figure 1 shows.          (D): S/FTP Kabel: Vorbereiten des Kabels</p>	<p>(E): F/FTP cable (Compact cable): Prepare the cable and cut foil as fig. 1 shows.          (D): F/FTP Kabel (Compact P/MF): Vorbereiten des Kabels.</p>	<p>(E): Colour coding according to T568 A and T568 B.          (D): Farbkodierung entsprechend T568 A und T568 B.</p>	<p>(E): Push the cable clamp to open it.          (D): Kabelklemme drücken.</p>
<p>(E): Insert the cable through hole until pair foil is visible on the opposite side. Release the cable clamp (It has to press on the shield of the cable jacket).          (D): Führen Sie das Kabel in die Kabelklemme ein, bis die Paarfolien auf der anderen Seite der Klemme sichtbar werden. Dann die Klemme freigegeben. Der Schirm wird auf den Kabelmantel gedrückt.</p>	<p><b>NOTE / BEMERKUNG:</b>          (E): The metal braid (S/FTP), metal foil (F/FTP) and drain wire (if any) must be in contact with the clamp.          (D): Die Kabelklemme bietet einen permanenten Federkontakt. Das Metallgeflecht bzw. die Metallfolie inkl. Drainadrht müssen den Federkontakt berühren.</p>	<p>(E): Sort the wires and place them in slots according to relevant colour coding (fig. 2).          (D): Einlegen der Adern entsprechend der gewählten Farbkodierung (Abbildung 2).</p>	<p>(E): Locate the rear housing (fig 5) into the front housing until it is engaged.          (D): Die Kabelklemme inkl. Kabel leicht von hinten in den Steckverbinder eindrücken.</p>
<p><b>NOTE / BEMERKUNG:</b>          (E): The dust cover must be opened prior to insertion into the tool. If the jack connector is terminated with the cover closed, the cover and/or the connector will be damaged.          (D): Die Staubschutzklappe muß vor dem Einlegen des Steckverbinders in das Tool geöffnet sein um Beschädigung während der Verarbeitung zu verhindern.</p>	<p>(E): Position the pre-assembled jack into the tool. Squeeze the handle down until the back part latches into the front part. The wires are cut automatically. Remove wires in closed position.          (D): Den Arm des Werkzeuges nach unten drücken. Dadurch verrasten der hintere und der vordere Teil des Steckverbinders. Die Adern werden automatisch geschneitten. Die Adern bei geschlossenen Werkzeug entfernen</p>		<p>(E): The connector is now terminated and ready to be applied to the environment application.          (D): Der Steckverbinder ist nun fertig angeschlossen.</p>
<p>(E): The jack fits in cut-out as drawing shows (As a reference).          (D): Der Steckverbinder paßt in Cutouts mit den geeigneten Maßen.</p>	<p><b>ONLY FOR REFERENCE</b></p>	<p>(E): For re-opening please use a small screw driver for a) unlocking the two side latches...          (D): Zum Öffnen des Jacks wird ein kleiner Schraubendreher benötigt, um a) die beidseitigen Nasen zu lösen...</p>	<p>(E): ...and b) for separating the front and the rear part.          (D): ... und b) um das Vorderteil und das Hinterteil zu trennen.</p>



How to prepare and crimp a BeoNet RJ45 plug on BeoNet product cable.



1. Slide the sheath onto the cable.



2. Strip the cable.



3. Fold the outside shield back over the jacket. In case of braid and foil together, foil must be trimmed maximum 2 mm.

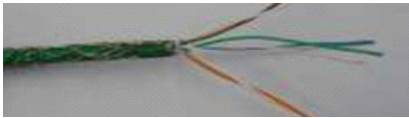

4. Foil of individual pair shields must be trimmed maximum 2 mm.



5. Slide the plug shield over the cable jacket and cable shield.



6. Position the pairs (according to Wiring B in this case).



7. Hold the positioned pairs firmly.

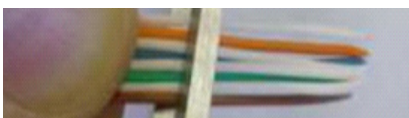

8. Make a preliminary cut to the pairs to help the insertion of the conductors into the wire holder.

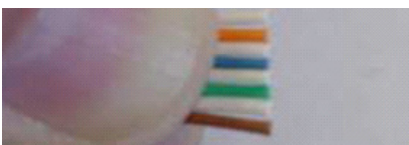

9. Conductors are ready for insertion.



10. Insert the conductors through the wire holder.



11. Slide the wire holder up to the jacket end.



12. Trim all conductors evenly and square with appropriate tooling.

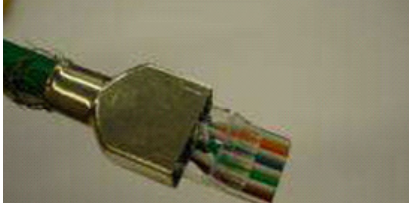

13. Conductors perfectly aligned at the wire holder edge.

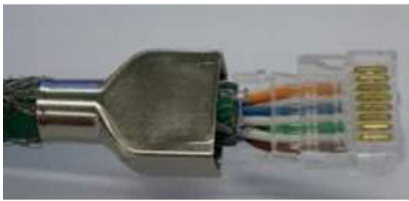

14. Insert the front of the wire holder into the plug housing cavity.



15. Push the wire holder into the housing until it latches.



16. Slide the plug shield over the plug subassembly.

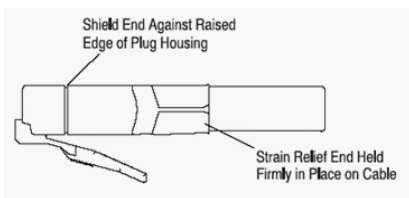

17. The shield end must be against the raised edge of the housing.

The strain relief end must be held firmly in place on the insulated position of the cable.

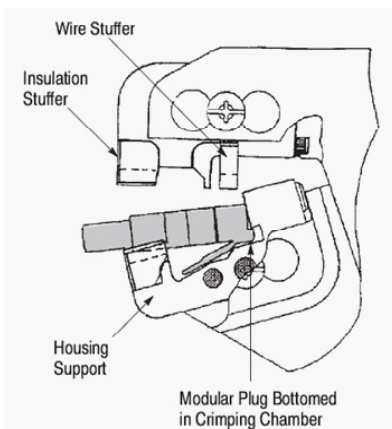

18. How to crimp the plug. Place the pre-assembled plug in tool and crimp.



19. Trim away any braid/foil and drain wire left extending beyond the end of the plug shield.



20. Slide the sheath over the crimped plug and shield. Plug is successfully crimped and ready for use.

## 10 How to test the installation

### 10.1 Simple Ethernet cable tester

Simple tester used to check if there are short/open circuit or cross wiring.

Use 2 patch cables for connecting the small unit and tester in wall outlet and technical room. When connected it will power up and show connections in display. User guide for this tester is available on BeoWise.



JDSU TP250 Simple Ethernet tester  
Used for simple check of installation  
Part number: 3624029  
Package size: 1 piece

### 10.2 Advanced cable tester

Each time an installation is finished, it is important to check that all connections are done correctly and that the cable has not been damaged during installation.

With the Fluke cable tester it is possible to make a complete test report of all connections. This report can be signed and handed over to the customer.

In the tester package there is also a user guide and pc software for Fluke CableIQ. User guide for CableIQ is also available for download at BeoWise.



Fluke CableIQ Advanced Ethernet tester  
Used for advanced validation of installation  
Part number: 3624030  
Package size: 1 piece

## 11 New infrastructure components

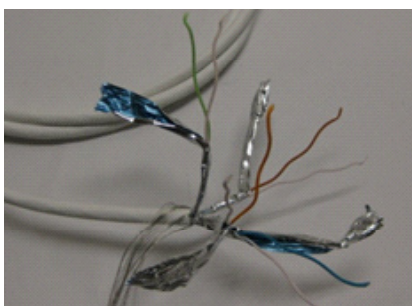

Cable is used for inwall installation

Part number: 6250027

Description: BeoNet cat7/Class F  
installation cable white

Reel size: 500 m/1625'

Plenum cable cat6/Class E for use in special  
areas where high demands regarding fire  
codes make it necessary

Part number: 6250030

Reel size: 500 m/1625'



Straight connector used for wall outlet.  
Installation cable goes straight into the  
connector.

Part number: 7221200

Description: BeoNet Connector RJ45  
Straight

Package size: 24 pieces

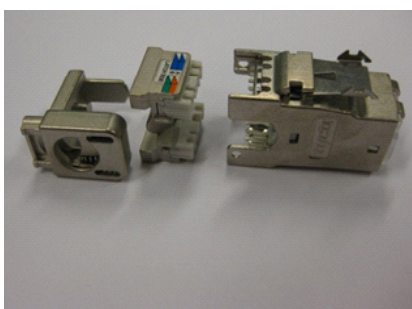

Angled connector used for wall outlet.

Installation cable goes into the side of the  
connector.

Part number: 7221201

Description: BeoNet Connector RJ45  
Angled

Package size: 24 pieces



Crimp tool for wall outlet connectors

Part number: 3624008

Description: Tool for BeoNet RJ45  
connector

Package size: 1 piece

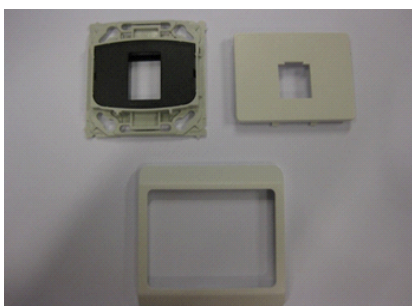

BeoNet Wall Plate DK Opus, white

Part number: 7211634

Package size: 1 piece



BeoNet Wall Plate DK Fuga, white  
Part number: 7211635  
Package size: 1 piece



BeoNet Wall Plate UK, white  
Part number: 7211636  
Package size: 1 piece

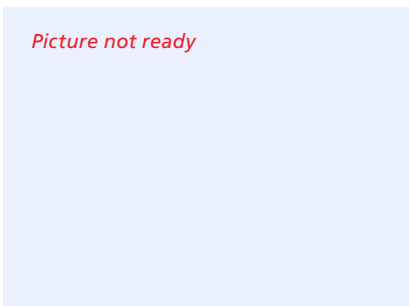

BeoNet Wall Plate DIN, white  
Part number: 7211637  
Package size: 1 piece

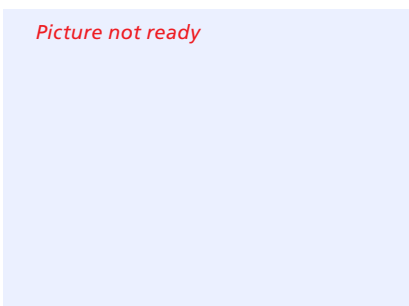

BeoNet Wall Plate US, white  
Part number: 3321424  
Package size: 1 piece



Product cable, also used as patch cables in  
BeoNet cabinet  
Part numbers:  
6271023 0.5 m/1.5 feet white  
6271024 1.5 m/4.5 feet white  
6271025 3.0 m/9.75 feet white  
6271026 5.0 m/16 feet white  
6271027 10.0 m/32 feet white  
6271028 20.0 m/64 feet white  
Package size: 1 piece



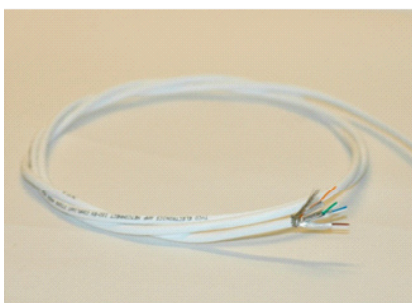

Product cable to make customised cables used between the wall outlet connector and a Bang & Olufsen product  
 Part number: 6250028  
 Description: BeoNet product cable, white  
 Reel size: 300 m/975 feet



RJ45 plug with white cover for BeoNet product cable only  
 Part number: 7221248  
 Package size: 25 pieces



Tool for RJ45 plug crimp  
 Part number: 3624009  
 Package size: 1 piece

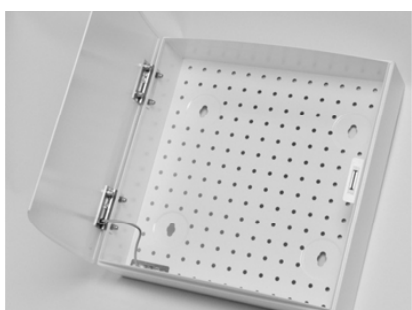

BeoNet cabinet, surface installation  
 Used as distribution centre.  
 Ground connectors are included.  
 H x W x D: 370 mm x 400 mm x 120 mm  
 H x W x D: 14.5" x 15.75" x 4.72"  
 Part number: 3400142  
 Package size: 1 piece

*Picture not ready*

BeoNet cabinet, build in  
 Used as distribution centre.  
 H x W x D:  
 H x W x D:  
 Part number: 3400140  
 Package size: 1 piece



Master Link patch module for cabinet mounting  
Part number: 8052351  
Package size: 1 piece



Power Link patch module for cabinet mounting  
Part number: 8052352  
Package size: 1 piece



BeoNet bracket for Patch Module in cabinet  
1 piece ground wire included  
Part number: 3153287  
Package size: 1 piece



BeoNet bracket for connector in cabinet  
1 piece ground wire included  
Maximum 18 connectors can be mounted on one bracket  
Part number: 3153293  
Package size: 1 piece

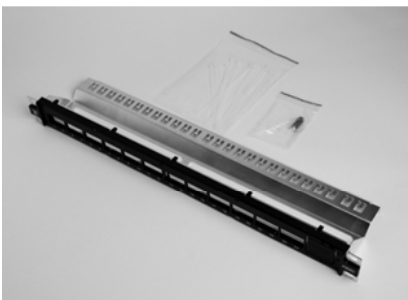

BeoNet bracket, connector for 19" rack  
Maximum 24 connectors can be mounted on one bracket  
Part number: 3153269  
Package size: 1 piece

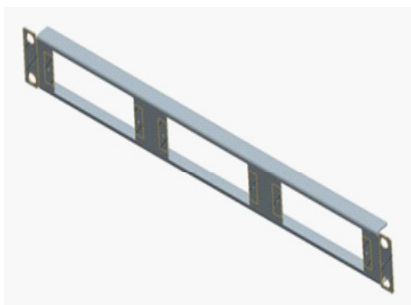

BeoNet bracket, Path Module for 19" rack

Part number: 3153286

Package size: 1 piece



Galvanic isolator

Used for isolation between incoming antenna signal and BeoNet installation

Part number: 8039004

Package size: 1 piece



Balanced to non balanced converter box.  
For speakers with non balanced input only.

BL6000, BL8000, BL4000 MK1 and older active speakers

Part number:

EU: 3376078

UK: not ready yet

US: not ready yet

AUS: not ready yet

Package size: 1 piece



Nanoperm coil. Only use if noise is experienced in speakers

Part number: 6710038

Package size: 1 piece



BeoNet Product cable ML-RJ45.

Part numbers:

6270006 1.5m/4.5' black

6270013 1.5m/4.5' white

6270011 3.0m/9.75' black

6270014 3.0/9.75' white

6270002 5.0 m/16' black

6270015 5.0 m/16' white

6270012 10.0 m/32' black

6270016 10.0 m/32' white

Package size: 1 piece



BeoNet product cable PL-RJ45

Part numbers:

6270017 1.5 m/4.5' black  
 6270023 1.5 m/4.5' white  
 6270020 3.0 m/9.75' black  
 6270024 3.0 m/9.75' white  
 6270004 5.0 m/16' black  
 6270025 5.0 m/16' white  
 6270022 10.0 m/32' black  
 6270026 10.0 m/32' white

## 12 Questions and answers

Question: Is it possible to crimp a RJ45 plug on existing Master Link or Power Link cables?

Answer: No, it will give reliability problems over time.

Question: Is it possible to crimp a RJ45 plug on cat7/Class F installation cable?

Answer: No. RJ45 plugs can only be crimped on BeoNet product cable.

Question: Do Bang & Olufsen accept use of other types than the preferred cat 7/Class F cables and connectors in an installation?

Answer: Bang & Olufsen cannot guarantee functionality with other types of cable/connector. An exception to this is LK LexCom Home/IHC net that also has been tested/approved to carry ML and PL connections. Cables and connectors from different manufactures must not be mixed in an installation.

Question: Is it possible to see how much cable I have used in an installation?

Answer: Installation cable is marked with forth going m (metre) indication. This way one can read the number when installation work starts, and then again when finished. The difference is the amount used for the installation.

Question: Can I mount a connector on the product cable in the same way as I mount it on the installation cable?

Answer: Yes. This way it is possible to make an extension cord (parts needed are connector 7221200, RJ45 plug 7221248 and cable 6250028).

Question: Can I use BeoNet product cable as installation cable?

Answer: Yes. In situations where a thinner cable are required ( e.g if two cables are to be pulled in one conduite), however used for ethernet the max lenght to switch/router is 50 m (160'). For Master link max 100m (320') can be BeoNet product cable, the rest should be BeoNet installation cable.